



Active Components Seed Laser Modules

Key Features

Up to 500 mW operating power

Operating temperature up to 75 °C

1050-1070 nm wavelength range

Pulsed operation from 30 ns to 500 ns

Telcordia GR-468-CORE qualified

MTTF > 100.000h

RoHS 6/6

Applications

Fiber Lasers

Sensors

Raman spectroscopy

1064CHP

500 mW 1060 nm Cooled Seed Laser Module

The 1064CHP 1060 nm high power single-mode laser module is a seed source designed for both pulsed and CW fiber laser applications that require operating wavelengths in the 1050-1070 nm range, and can be used as a pump module as well.

This seed / pump module is powered by an in-house chip technology fully qualified, ensuring an outstanding level of performance, power consumption and reliability.

Low Profile, 14-pin butterfly modules are available with an operating power up to 500 mW CW and 1.2 W peak power. They incorporate a thermoelectric cooler (TEC), a precision NTC thermistor and a back-facet monitoring photodiode.

Modules are available with a single mode Polarization Maintaining Fiber (PMF) pigtail.

The module meets the Telcordia™ GR-468-Core requirements for hermetic pump modules.

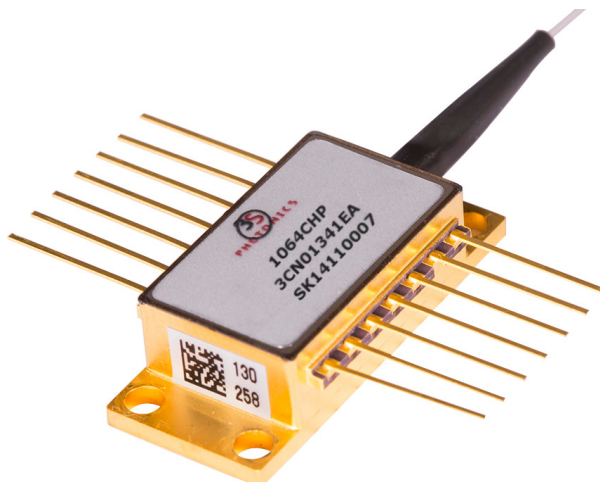

For more Info

Please contact us at:
Europe & Asia: +33 169 805 833
North America: +1 514 748 4848
+1 888 922 1044
sales@3spgroup.com

1064CHP

500 mW 1060 nm
Cooled Seed / Pump
Laser Module

3SPTechnologies
Source of Smart Solutions

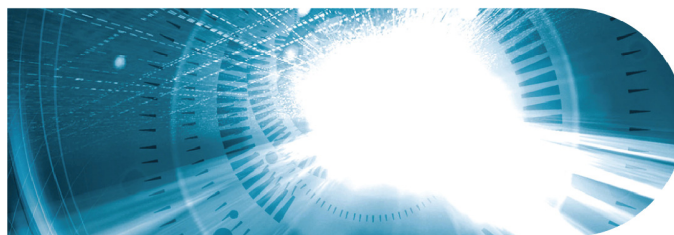

2

ELECTRO-OPTICAL CHARACTERISTICS

The following parameters are specified BOL for a $T_{\text{submount}} = 25\text{ }^{\circ}\text{C}$, $T_{\text{case}} = -5\text{ }^{\circ}\text{C}$ to $75\text{ }^{\circ}\text{C}$, VBFM= -5 V and -50 dB max back-reflection unless otherwise stated.

Parameters	Conditions	Symbol	Min	Typ	Max	Unit
PUMP LASER						
Threshold current	Note 1	I_{th}	-	60	80	mA
Nominal operating power	@ 800 mA @ 1000 mA	P_{nom}	400 500	420 525	- -	mW
Peak wavelength	Note 2	λ_{p}	1050	-	1070	nm
Forward voltage	P_{nom}	V_{nom}	-	1.6	2.0	V
Operating peak power	<500 ns / 500 kHz	P_{opp}	0.9	1.0	-	W
Operating peak current	<500 ns / 500 kHz	I_{opp}	-	-	2	A
MONITOR DIODE						
Responsivity		dI_{BFM} / dP	0.5	-	10	$\mu\text{A}/\text{mW}$
Dark current	$V_{\text{r}} = 5\text{ V}$	$I_{\text{BFM_dark}}$	-	50	100	nA
THERMO-ELECTRICAL COOLER						
Cooling capacity		ΔT_{TEC}	50	-	-	$^{\circ}\text{C}$
TEC voltage (EOL)	$T_{\text{case}} = 75\text{ }^{\circ}\text{C}$, $1.1 \times I_{\text{nom}}$	$V_{\text{TEC, EOL}}$	-	-	3.3	V
TEC current (EOL)	$T_{\text{case}} = 75\text{ }^{\circ}\text{C}$, $1.1 \times I_{\text{nom}}$	$I_{\text{TEC, EOL}}$	-	-	2.0	A
TEC power consumption	$T_{\text{case}} = 75\text{ }^{\circ}\text{C}$, $1.1 \times I_{\text{nom}}$	P_{TEC}	-	-	5.05	W
THERMISTOR						
Resistance	25 $^{\circ}\text{C}$	R_{th}	9.5	10	10.5	k Ω
Constant		β	3600	-	4200	K

Note 1: I_{th} is the intersection point with the x-axis of a linear fit of the P(I) curve between 15 mW and 50 mW

Note 2: Center Wavelength target upon customer request

1064CHP

500 mW 1060 nm
Cooled Seed / Pump
Laser Module

3SPTechnologies
Source of Smart Solutions

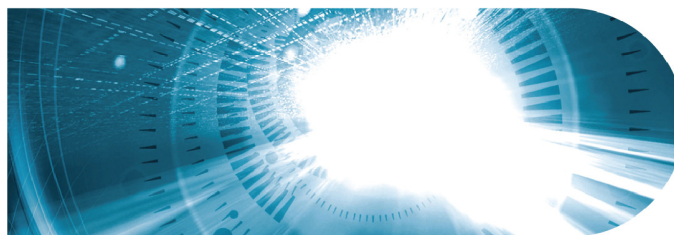

ABSOLUTE MAXIMUM RATINGS

Exposing this device to stresses and conditions above those listed in this section could cause permanent damage and affect reliability. The device is not meant to operate outside the operational limits described in previous section at any length of time.

Parameter Conditions	Symbol	Min	Max	Unit
Storage temperature (2000 h)	T_{stg}	-40	85	°C
Operating temperature ($T_{submount} = 25$ °C)	T_{op}	-5	75	°C
Lead soldering temperature (10 s maximum)		-	280	°C
LD forward drive current (10 s maximum)	I_{f_max}	-	1100	mA
LD reverse voltage	V_{r_max}	-	2.0	V
PD reverse voltage	V_{PD_max}	-	15	V
PD forward current	I_{PD_max}	-	10	mA
TEC voltage	$V_{TEC_C_max}$	-	4.2	V
TEC current	$I_{TEC_C_max}$	-	2.0	A
ESD* damage	V_{ESD}	-	500	V
Mounting torque		-	150	mN.m
Fiber bend radius		16	-	mm
Axial pull force (1x1min)		-	5	N

* Human Body model, C = 100 pF, R = 1.5 k Ω

FIBER PIGTAIL CHARACTERISTICS

Parameter	Note	Min	Typ	Max	Unit
Fiber type		SM98-PS-U25A-H or equivalent			
Coating diameter		230	250	270	μ m
Loose tube buffer diameter		885	-	915	μ m
Fiber proof test level		200	-	-	kpsi
Pigtail termination		ferrule			
Polarization State		Aligned parallel to the slow axis			

1064CHP

500 mW 1060 nm
Cooled Seed / Pump
Laser Module

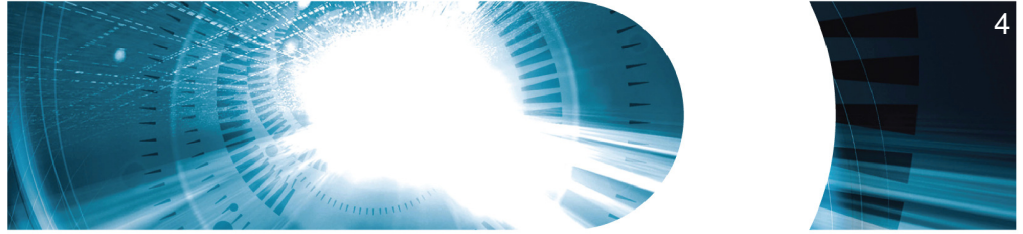

MECHANICAL DETAILS

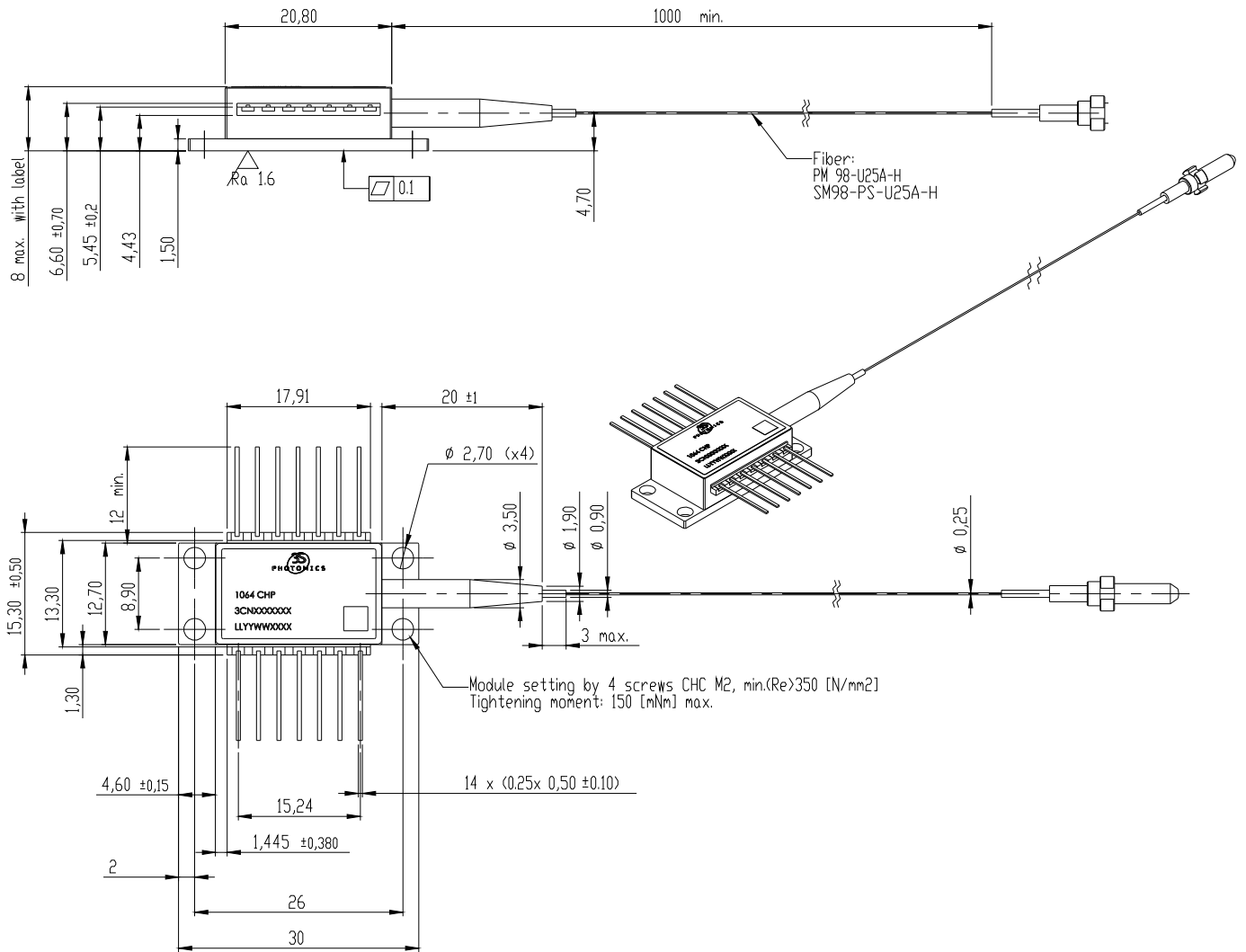

Dimensions are in mm

PIN ASSIGNMENT

N°	Description	N°	Description
1	TEC (+)	8	No connect
2	Thermistor	9	No connect
3	Monitor PD Anode	10	Laser Anode (+)
4	Monitor PD Cathode	11	Laser Cathode (-)
5	Thermistor	12	No connect
6	No connect	13	Ground
7	No connect	14	TEC (-)

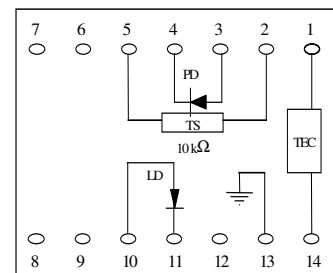

Totally floating pin-out

1064CHP

500 mW 1060 nm
Cooled Seed / Pump
Laser Module

3SPTechnologies
Source of Smart Solutions

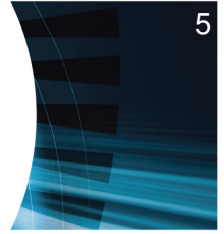
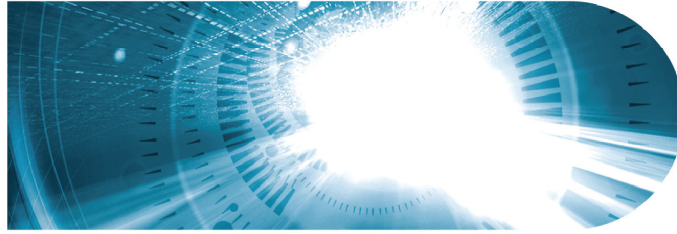

LASER SAFETY INFORMATION

This laser module emits invisible light. Take appropriate precautions to prevent undue exposure to naked eye when module is in operation. This product is classified Class 4 Laser Product according to IEC-60825-1.

HANDLING

This product is sensitive to electrostatic discharge and should not be handled except at a static free workstation. Take precautions to prevent ESD; use wrist straps, grounded work surfaces and recognized anti-static techniques when handling the pump laser module. Caution! Handle the module by its package only; never hold it by its pigtail. Care should be taken to avoid supply transient currents and voltages. Drive voltage above the maximum specified in absolute maximum rating section may cause permanent damage to the device.

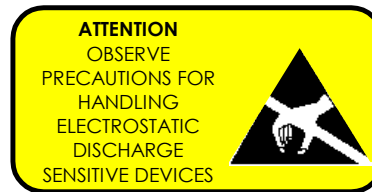

APPLICATION NOTE

In order to prevent any mishandling, misuse, neglect or accident, it is highly recommended to read and follow the instructions detailed in the application note:

[RCL IMA APN 000 00007 "Handling, Mounting, Testing and Operating Cooled 14-pin Butterfly Laser Pumps"](#)

ORDERING INFORMATION

1064CHP 1060 NM PUMP PRODUCT FAMILY

PMF pigtail	$\lambda_p = 1060 \text{ nm}$, $T = 25 \text{ }^\circ\text{C}$
Nominal Power	Part Number
400 mW	3CN01341DA
500 mW	3CN01341EA

3SP Technologies can also develop custom products to meet a wide range of technical requirements. Please contact your Sales Manager for details.

1064CHP

500 mW 1060 nm
Cooled Seed / Pump
Laser Module

3SPTechnologies
Source of Smart Solutions



CONTACT INFORMATION

Europe & Asia: +33 169 805 833
North America: +1 514 748 4848
+1 888 922 1044

sales@3spgroup.com
www.3spgroup.com

IMPORTANT NOTICE

Information in this document is typical and must be specifically confirmed in writing by your supplier before it becomes applicable to any order or contract.

Information is subject to change without notice.

©2015 3SP Technologies S.A.S.

