

Active Components Pump Laser Modules

Key Features

Up to 750 mW operating power

Operating temperature up to 75 °C

Fiber Bragg Grating (FBG) on either PMF or SMF

Total Power Consumption:
7.8 W max @ 750 mW Pop

Telcordia GR-468-CORE qualified

RoHS compliant

Applications

High output power low noise
Erbium-Doped Fiber Amplifier

Sensors

CATV

Wavelength conversion

For more Info

Please contact us at:
Europe & Asia: +33 169 805 833
North America: +1 514 748 4848
+1 888 922 1044
sales@3spgroup.com

1999CHP

825 mW Kink-Free, FBG Stabilized, 980 nm Cooled Pump Laser Module

The 1999CHP is a new generation of 980 nm terrestrial pump modules powered by in-house chip technology fully qualified for submarine applications, ensuring an outstanding level of performance, power consumption and reliability.

Low Profile, 14-pin butterfly modules are available with an operating power up to 750 mW.

They incorporate a thermoelectric cooler (TEC), a precision NTC thermistor and a back-facet monitoring photodiode.

The wavelength is "locked" utilizing a fiber bragg grating (FBG) located in either a single mode Polarization Maintaining Fiber (PMF) or a Single Mode HI1060 Fiber (SMF) pigtail.

The module meets the Telcordia™ GR-468-Core requirements for hermetic 980 nm pump modules.

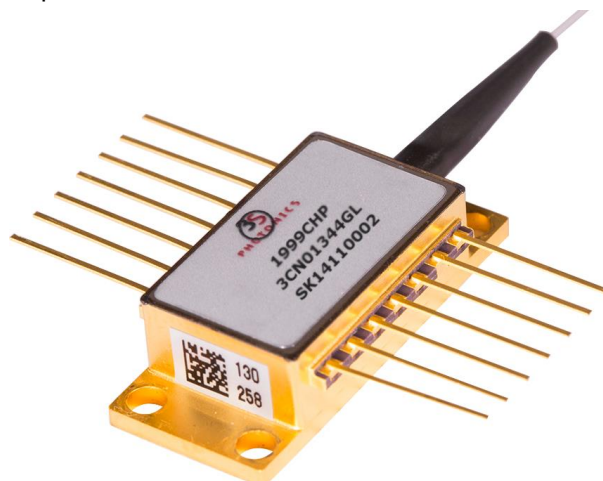

**825 mW Kink-Free,
FBG Stabilized,
980 nm Cooled
Pump Laser Module**

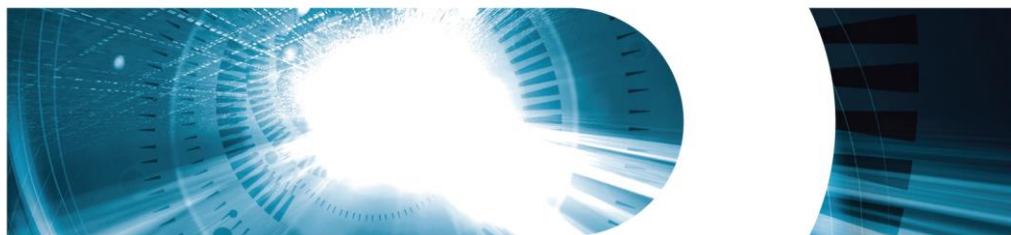

ELECTRO-OPTICAL CHARACTERISTICS

The following parameters are specified BOL for a $T_{\text{case}} = -5\text{ °C}$ to 75 °C , $V_{\text{BFM}} = -5\text{ V}$ and -50 dB max back-reflection unless otherwise stated.

Parameters	Conditions	Symbol	Min	Typ	Max	Unit
PUMP LASER						
Threshold current ⁽¹⁾		I_{th}	-	60	80	mA
Nominal operating power		P_{nom}	350	600	750	mW
Kink free power ⁽²⁾		P_{kink}	$1.1 \times P_{\text{nom}}$	-	-	mW
Forward current ⁽³⁾	$P_{\text{nom}} = 350\text{ mW}$	I_{nom}	-	605	665	mA
	$P_{\text{nom}} = 400\text{ mW}$		-	685	750	
	$P_{\text{nom}} = 450\text{ mW}$		-	765	835	
	$P_{\text{nom}} = 480\text{ mW}$		-	815	885	
	$P_{\text{nom}} = 500\text{ mW}$		-	845	920	
	$P_{\text{nom}} = 520\text{ mW}$		-	875	960	
	$P_{\text{nom}} = 550\text{ mW}$		-	925	1005	
	$P_{\text{nom}} = 600\text{ mW}$		-	1005	1085	
	$P_{\text{nom}} = 680\text{ mW}$		-	1100	1120	
	$P_{\text{nom}} = 720\text{ mW}$	-	1110	1130		
	$P_{\text{nom}} = 750\text{ mW}$	-	1140	1150		
Forward voltage	@ 750 mW	V_{nom}	-	1.9	2.2	V
Peak wavelength tolerance	@ $T_{\text{case}} = T_{\text{FBG}} = 25\text{ °C}$ $0.1 \times P_{\text{nom}}$ to P_{nom}	$\Delta\lambda_p$	-	-	± 0.5	nm
Wavelength tuning vs temperature ($T_{\text{grating}} = -5$ to 75 °C)	$0.1 \times P_{\text{nom}}$ to P_{nom}	$\Delta\lambda_p / \Delta T$	-	0.01	0.02	nm / °C
Spectral width @ -3 dB	$0.1 \times P_{\text{nom}}$ to P_{nom}	$\Delta\lambda_{\text{FWHM}}$	-	0.6	1.0	nm
Power in band ⁽⁴⁾	P_{nom}	P_{band}	90	-	-	%
Optical power stability	Peak to peak, 10 Hz-50 kHz, 60 sec, P_{nom}	ΔP	-	<1	2	%
Power consumption, EOL	$P_{\text{nom}} = 750\text{ mW}$		-	-	7.8	W
MONITOR DIODE						
Responsivity		I_{BFM} / P	0.5	-	10	$\mu\text{A} / \text{mW}$
Dark current	$V_r = 5\text{ V}$	$I_{\text{BFM_dark}}$	-	50	100	nA
THERMO-ELECTRICAL COOLER						
Cooling capacity		ΔT_{TEC}	50	-	-	°C
TEC voltage (EOL)	$T_{\text{case}} = 75\text{ °C}$, $1.1 \times I_{\text{nom}}$	$V_{\text{TEC, EOL}}$	-	-	3.3	V
TEC current (EOL)		$I_{\text{TEC, EOL}}$	-	-	1.5	A
TEC Power consumption		P_{TEC}	-	-	4.95	W
THERMISTOR						
Resistance	25 °C	R_{th}	9.5	10	10.5	k Ω
Constant		B	3600	-	4200	K

(1) I_{th} is the intersection point with the x-axis of a linear fit of the P(I) curve between 15 mW and 50 mW

(2) A kink is detected when the local slope dP/dI is below S_{min} or above S_{max} . S_{min} is defined as $0.5 \times S_{\text{avg}}$ and S_{max} is defined as $1.5 \times S_{\text{avg}}$

(3) EOL forward current $I(\text{EOL}) = 1.1 \times I(\text{BOL})$

(4) P_{band} is defined as the power within the band $\lambda_p \pm 1.5\text{ nm}$ vs the total output power

**825 mW Kink-Free,
FBG Stabilized,
980 nm Cooled
Pump Laser Module**

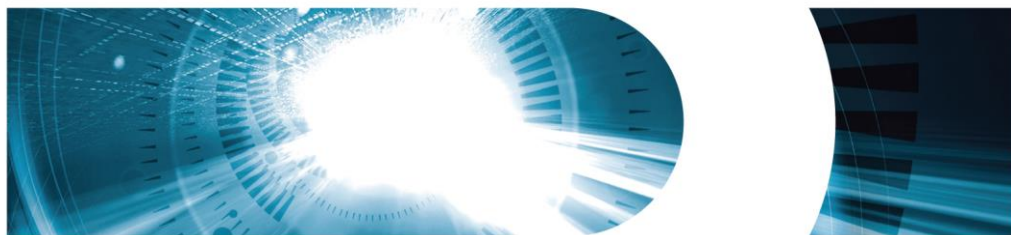

ABSOLUTE MAXIMUM RATINGS

Exposing this device to stresses and conditions above those listed in this section could cause permanent damage and affect reliability. The device is not meant to operate outside the operational limits described in previous section at any length of time.

Parameter Conditions	Symbol	Min	Max	Unit
Storage temperature (2000 h)	T_{stg}	-40	85	°C
Operating temperature ($T_{submount} = 25\text{ °C}$)*	T_{op}	-20	75	°C
Lead soldering temperature (10 s maximum)		-	280	°C
LD forward drive current (10 s maximum)	I_{f_max}	-	1300	mA
LD reverse voltage	V_{r_max}	-	2.0	V
PD reverse voltage	V_{PD_max}	-	15	V
PD forward current	I_{PD_max}	-	10	mA
TEC voltage	$V_{TEC_C_max}$	-	4.2	V
TEC current	$I_{TEC_C_max}$	-	2.0	A
ESD** damage	V_{ESD}	-	1000	V
Mounting torque		-	150	mN.m
Fiber bend radius		25	-	mm
Axial pull force (1x1 min)		-	5	N

* No cold start. TEC will be turned on first.

** Human Body model, C = 100 pF, R = 1.5 kΩ

FIBER PIGTAIL CHARACTERISTICS

Parameter	Note	Min	Typ	Max	Unit
Fiber type		PMF version: SM98-PS-U25A-H or equivalent SMF version: HI1060™ or equivalent			
Coating diameter	(except along grating)	230	250	270	μm
FBG recoat diameter		-	-	400	μm
FBG position	Module to center of FBG	-	2	-	m
Loose tube buffer diameter		885	-	915	μm
Fiber proof test level		200	-	-	kpsi
Grating proof test level		150	-	-	kpsi
Pigtail termination	Bare fiber				
Polarization State	Aligned parallel to the slow axis				

**825 mW Kink-Free,
FBG Stabilized,
980 nm Cooled
Pump Laser Module**

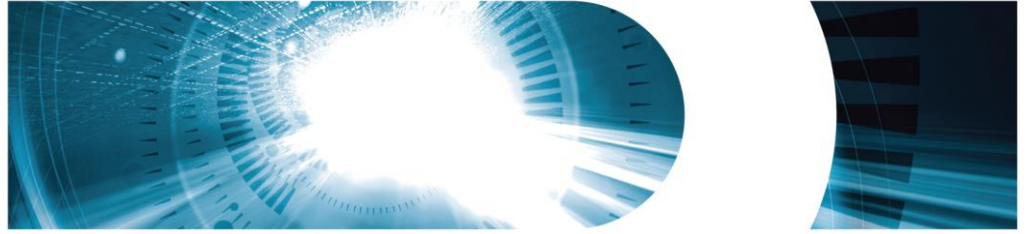

MECHANICAL DETAILS

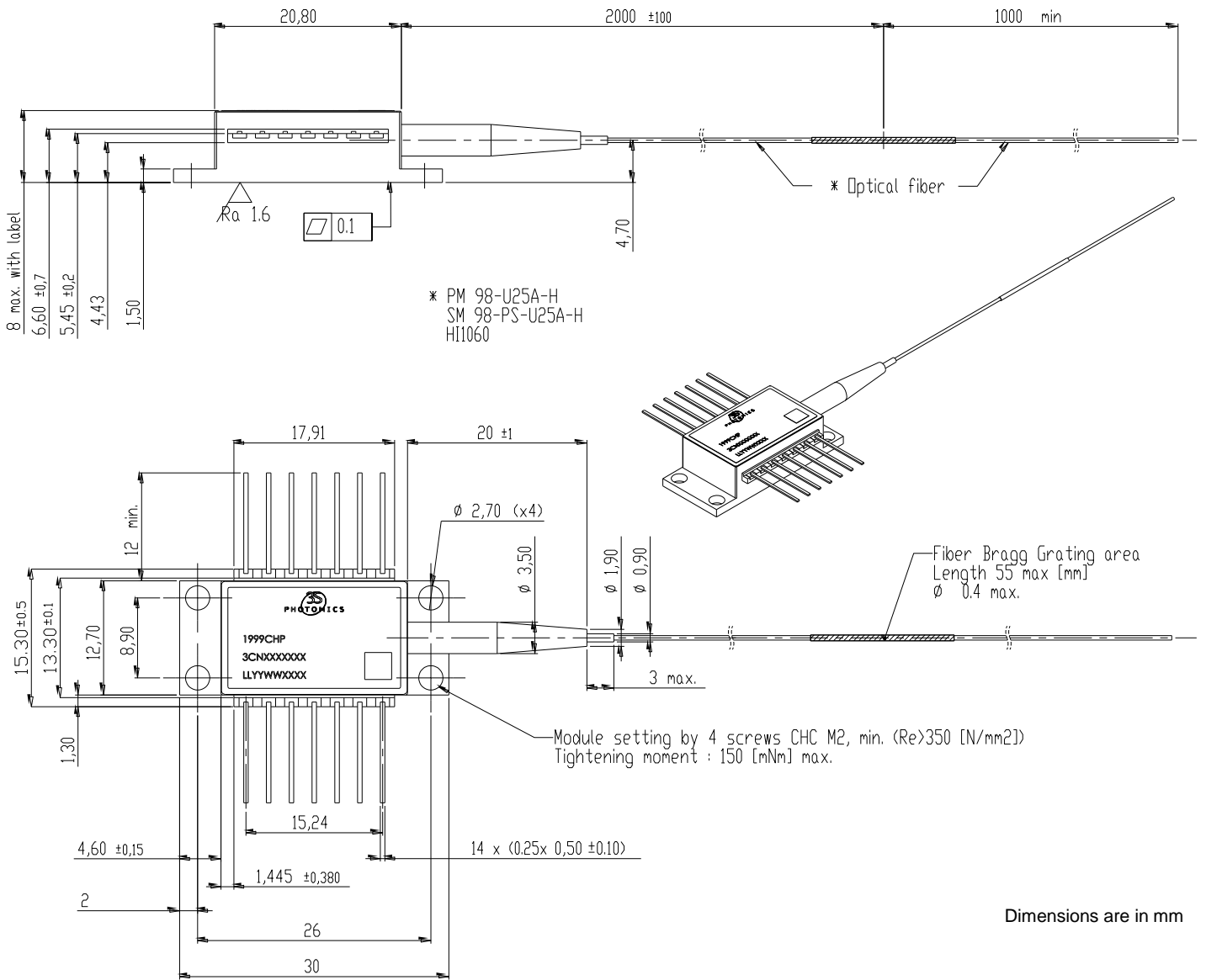

PIN ASSIGNMENT

N°	Description	N°	Description
1	TEC (+)	8	No connect
2	Thermistor	9	No connect
3	Monitor PD Anode	10	Laser Anode (+)
4	Monitor PD Cathode	11	Laser Cathode (-)
5	Thermistor	12	No connect
6	No connect	13	Ground
7	No connect	14	TEC (-)

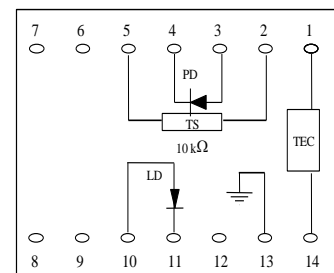

Totally floating pin-out

1999CHP



825 mW Kink-Free,
FBG Stabilized,
980 nm Cooled
Pump Laser Module

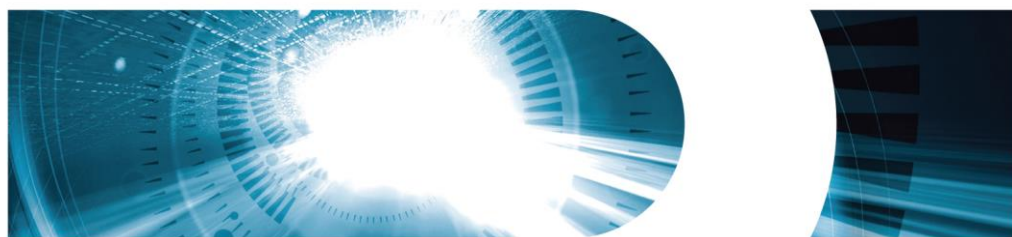

LASER SAFETY INFORMATION

This laser module emits invisible light. Take appropriate precautions to prevent undue exposure to naked eye when module is in operation. This product is classified Class 4 Laser Product according to IEC-60825-1.

HANDLING

This product is sensitive to electrostatic discharge and should not be handled except at a static free workstation. Take precautions to prevent ESD; use wrist straps, grounded work surfaces and recognized anti-static techniques when handling the pump laser module. Caution! Handle the module by its package only; never hold it by its pigtail. Care should be taken to avoid supply transient currents and voltages. Drive voltage above the maximum specified in absolute maximum rating section may cause permanent damage to the device.

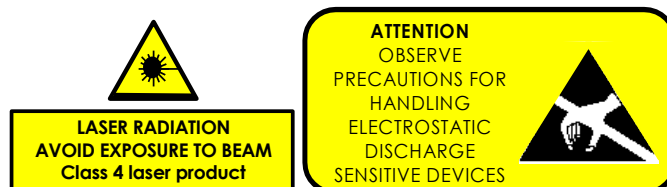

APPLICATION NOTE

In order to prevent any mishandling, misuse, neglect or accident, it is highly recommended to read and follow the instructions detailed in the application note:

RCL IMA APN 000 00007 "Handling, Mounting, Testing and Operating Cooled 14-pin Butterfly Laser Pumps"

ORDERING INFORMATION

1999CHP PUMP PRODUCT FAMILY

SMF Pigtail	$\lambda_p=974.5$ nm, T= 25 °C	$\lambda_p=976.0$ nm T= 25 °C	PMF Pigtail	$\lambda_p=974.5$ nm, T= 25 °C	$\lambda_p=976.0$ nm T= 25 °C	$\lambda_p=979.5$ nm, T= 25 °C	$\lambda_p=980.0$ nm T= 25 °C	$\lambda_p=981.0$ nm, T= 25 °C
Nominal Power	Part Number	Part Number	Nominal Power	Part Number	Part Number	Part Number	Part Number	Part Number
450 mW	3CN01350DL	3CN01351DL	350 mW	3CN01178CL	3CN01344CL	-	-	-
480 mW	3CN01350DS	3CN01351DS	400 mW	3CN01178DA	3CN01344DA	-	-	-
500 mW	3CN01350EA	3CN01351EA	450 mW	3CN01178DL	3CN01344DL	-	-	-
520 mW	3CN01350EE	3CN01351EE	500 mW	3CN01178EA	3CN01344EA	-	-	-
550 mW	3CN01350EL	3CN01351EL	550 mW	3CN01178EL	3CN01344EL	-	-	-
600 mW	3CN01350FA	3CN01351FA	600 mW	3CN01178FA	3CN01344FA	3CN01382FA	3CN01458FA	3CN01423FA
680 mW	3CN01350FS	3CN01351FS	680 mW	3CN01178FS	3CN01344FS	3CN01382FS	3CN01458FS	3CN01423FS
720 mW	3CN01350GE	3CN01351GE	700 mW	3CN01178GA	3CN01344GA	3CN01382GA	3CN01458GA	3CN01423GA
750 mW	3CN01350GL	3CN01351GL	720 mW	3CN01178GE	3CN01344GE	3CN01382GE	3CN01458GE	3CN01423GE
			750 mW	3CN01178GL	3CN01344GL	3CN01382GL	3CN01458GL	3CN01423GL

3SPGroup can also develop custom products to meet a wide range of technical requirements. Please contact your Sales Manager for details.

1999CHP

825 mW Kink-Free,
FBG Stabilized,
980 nm Cooled
Pump Laser Module

3SPGroup

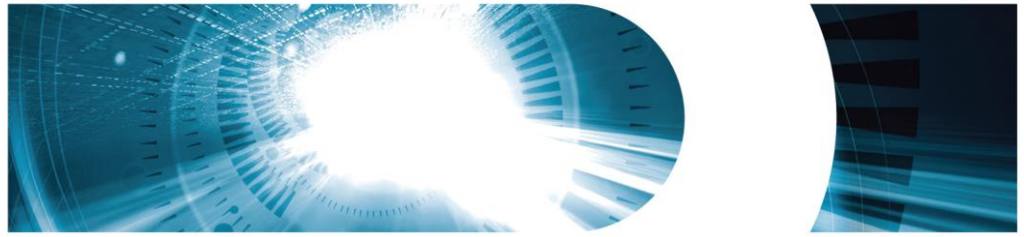

CONTACT INFORMATION

Europe & Asia: +33 169 805 833
North America: +1 514 748 4848
+1 888 922 1044

sales@3spgroup.com
www.3spgroup.com

IMPORTANT NOTICE

Information in this document is typical and must be specifically confirmed in writing by your supplier before it becomes applicable to any order or contract.

Information is subject to change without notice.

NOTES